

SEZIONE A-A

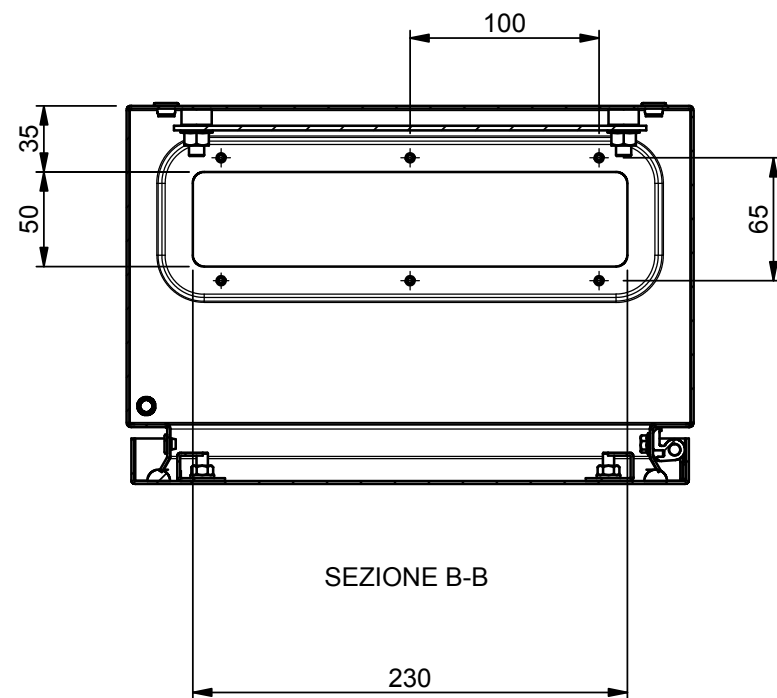

SEZIONE B-B

CASSE ST
300X400X200

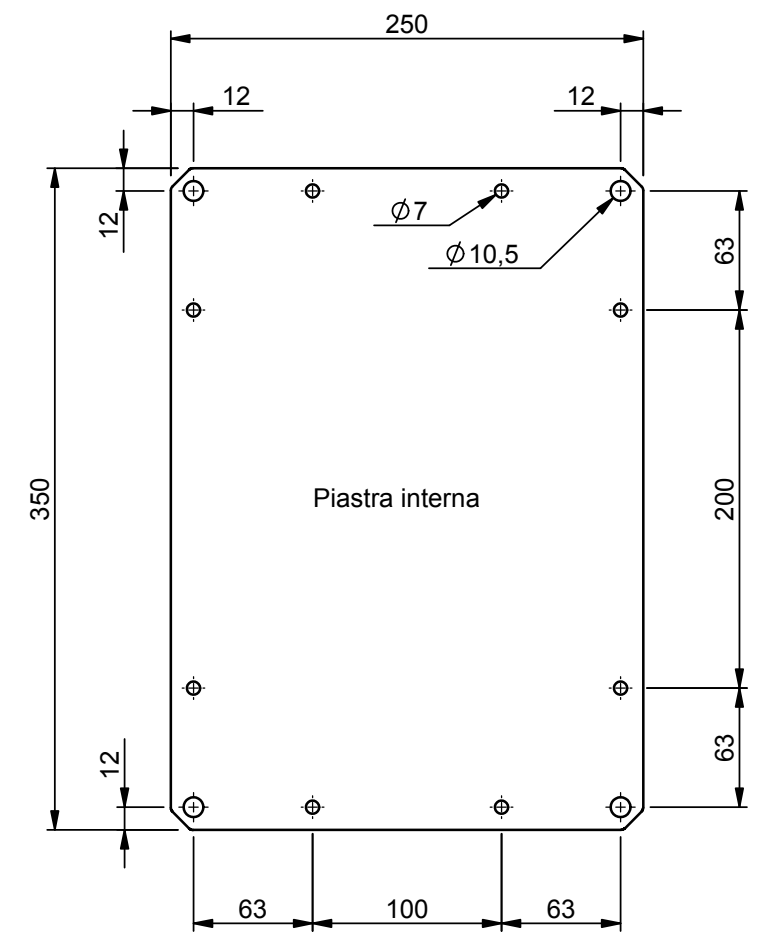
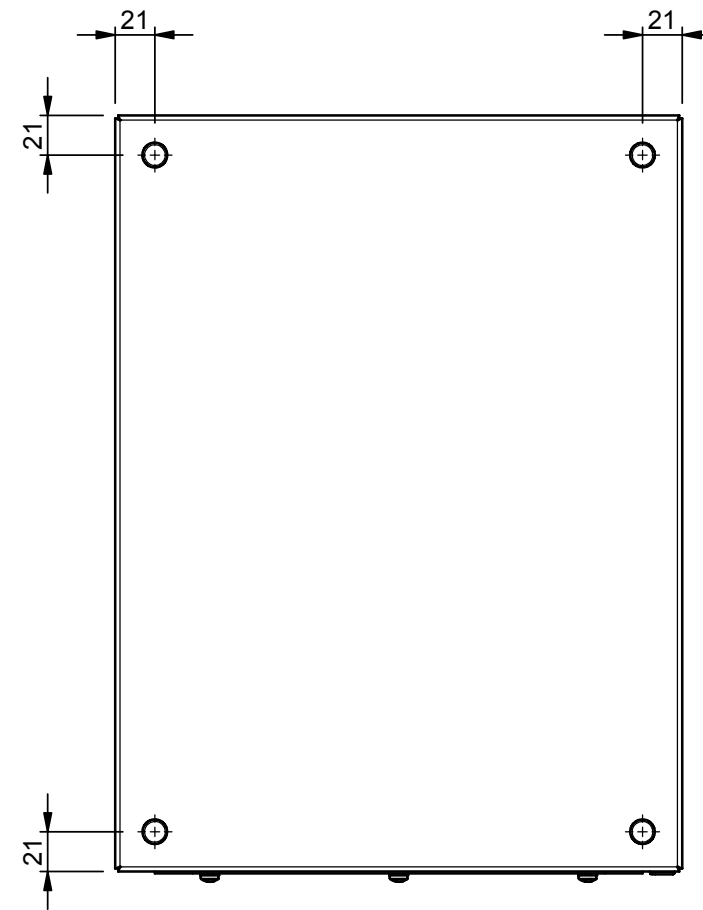

ST3_420