

SEZIONE A-A

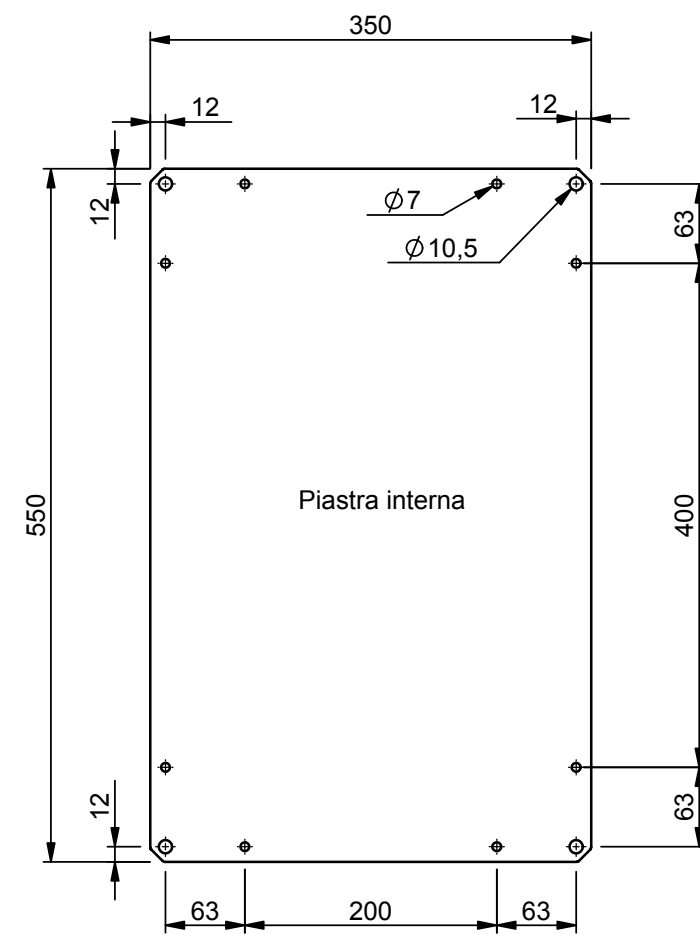

CASSE ST
400X600X400

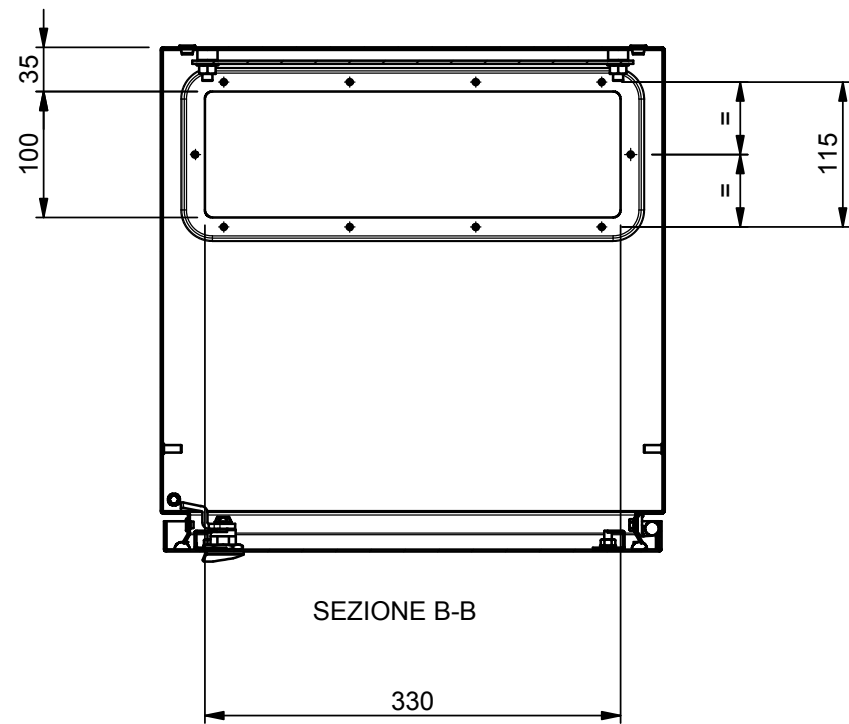
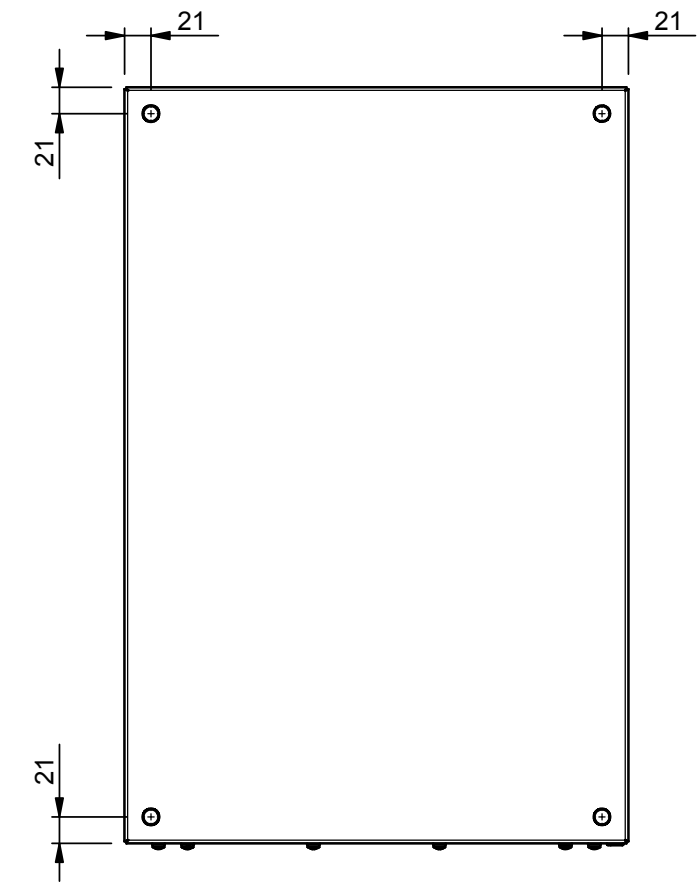

ST4_640