

SEZIONE A-A

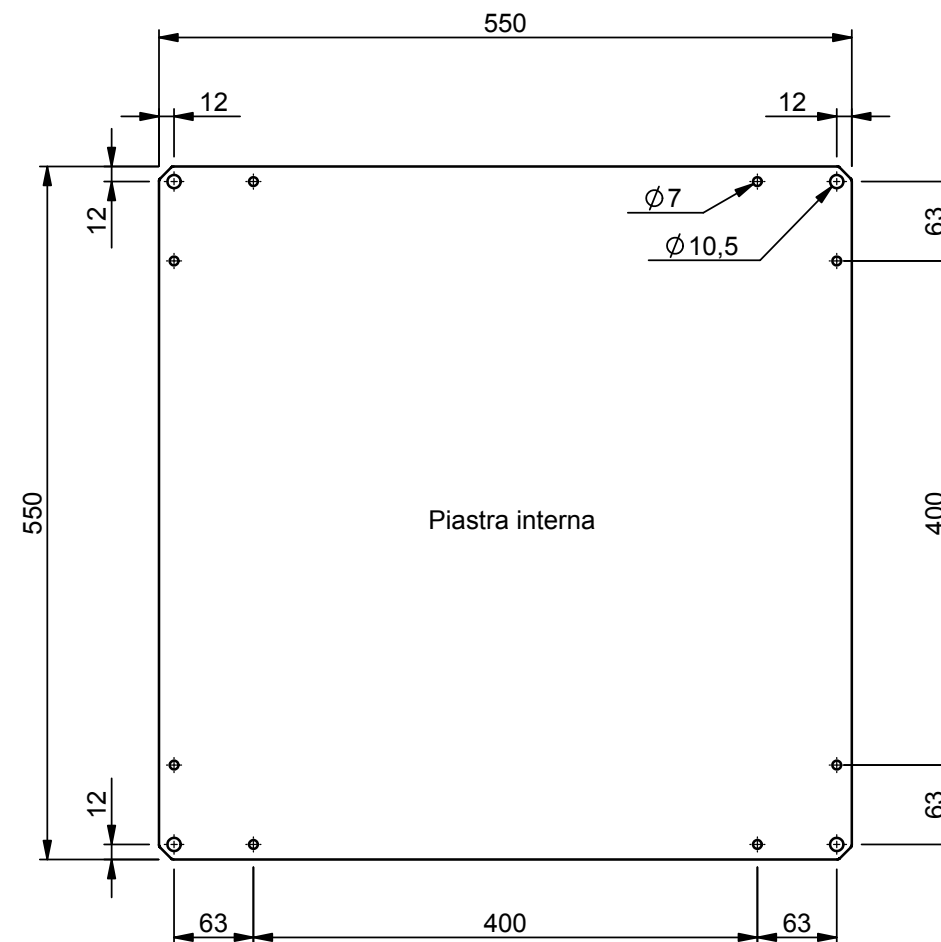

CASSE ST
600X600X400

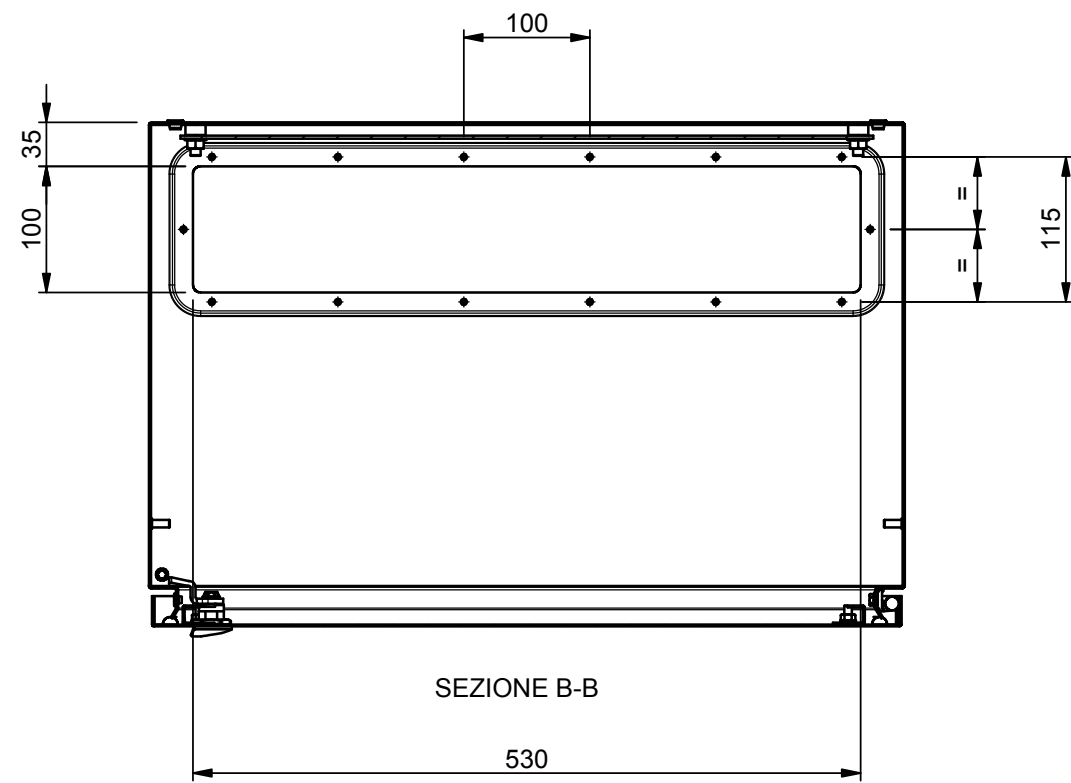
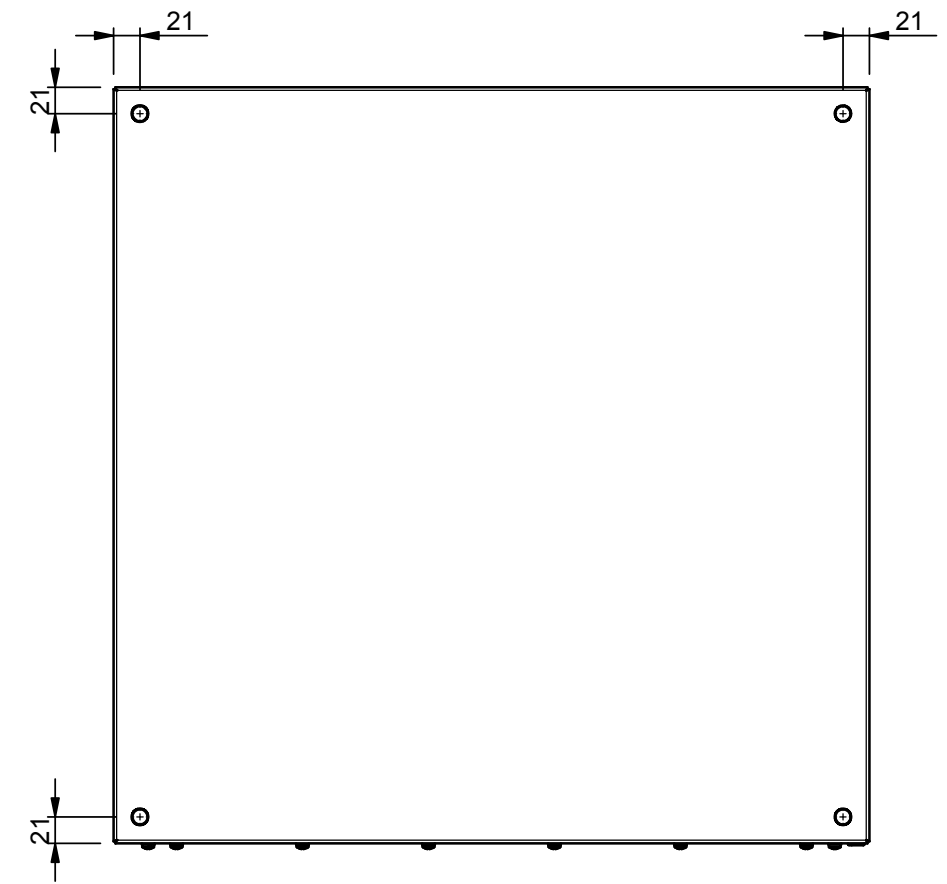

ST6_640