

SEZIONE A-A

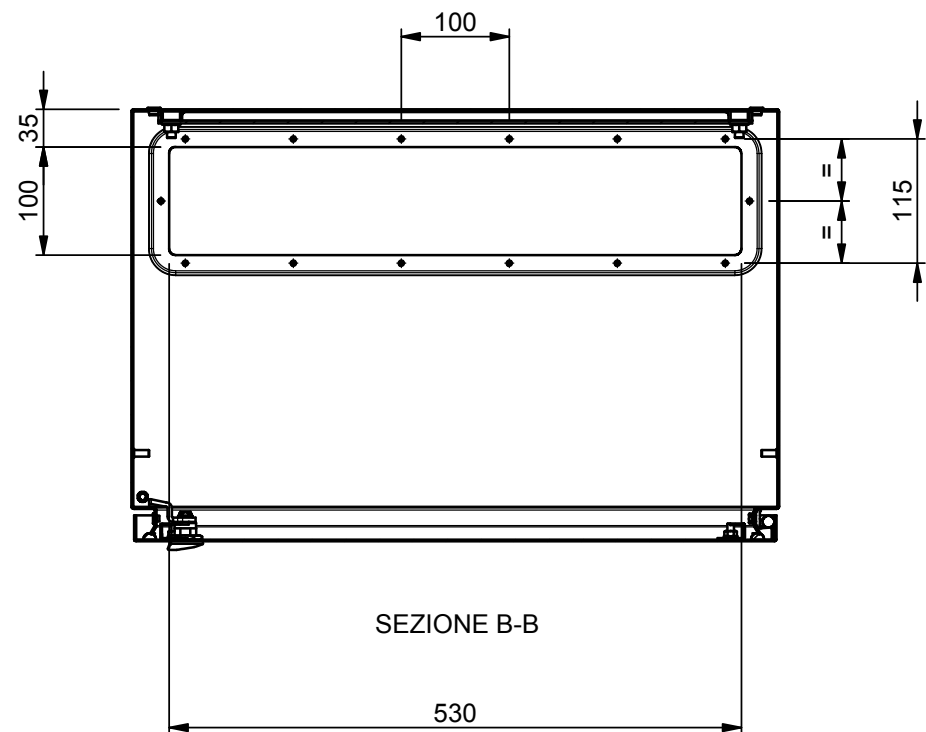

SEZIONE B-B

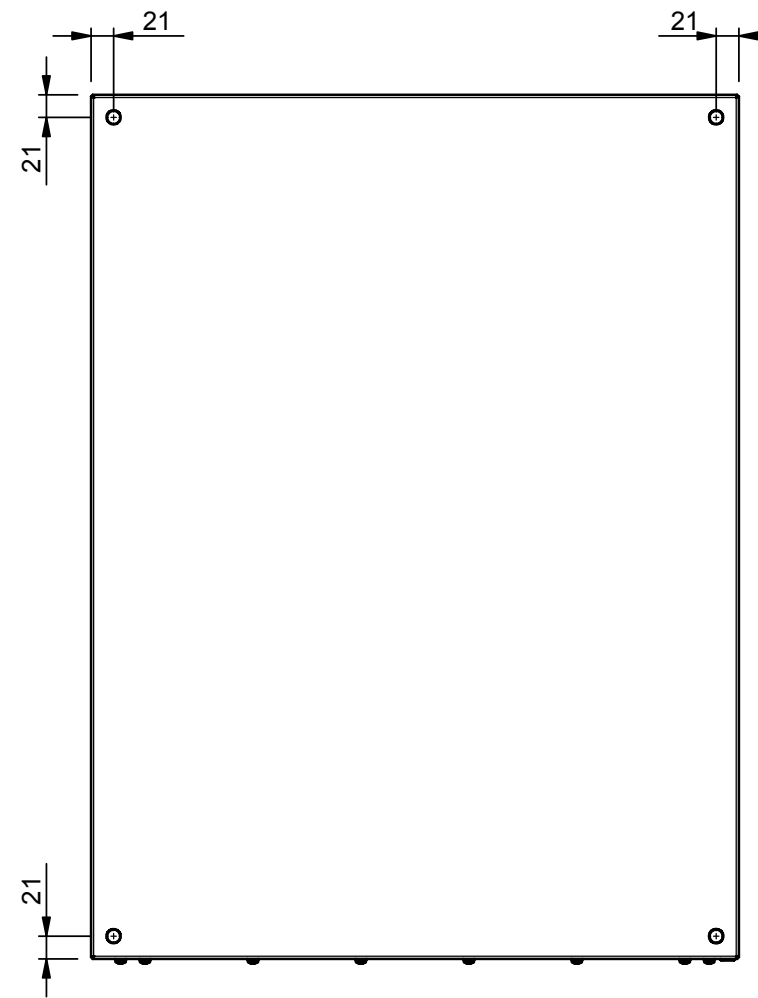
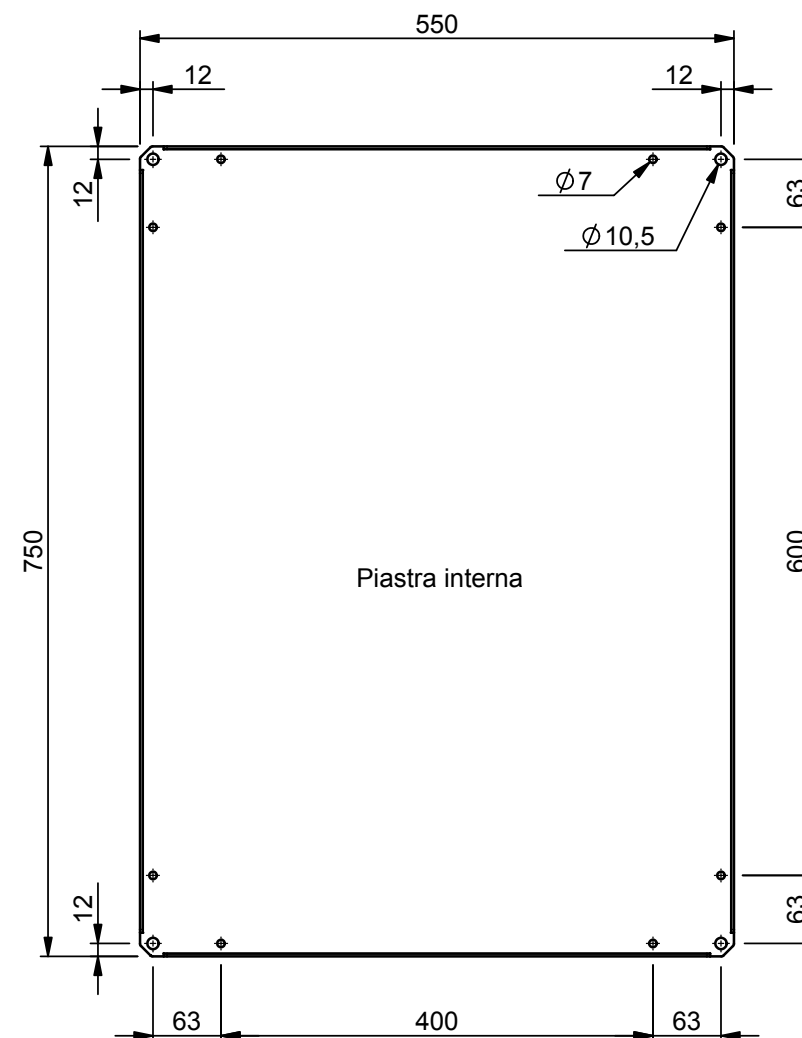

CASSE ST
600X800X400



ST6_840