

SEZIONE A-A

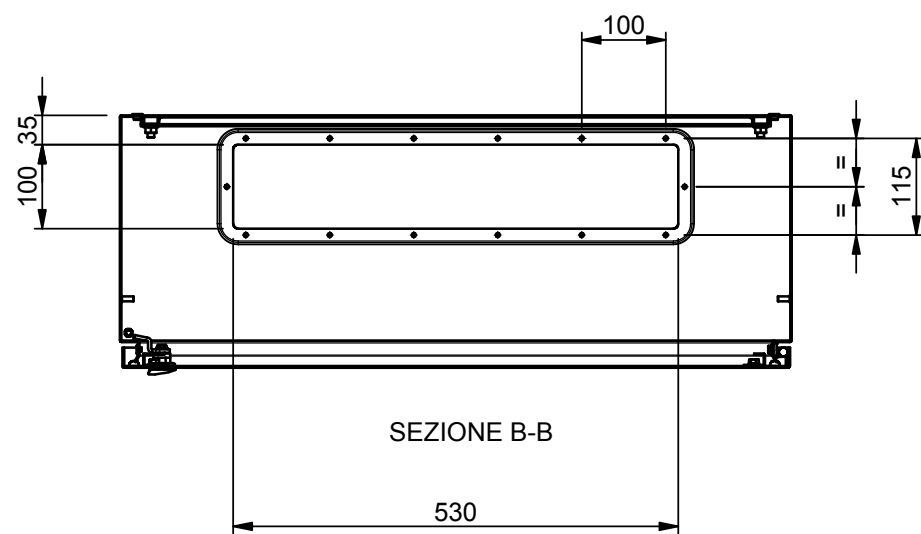

SEZIONE B-B

CASSE ST
800X1200X300

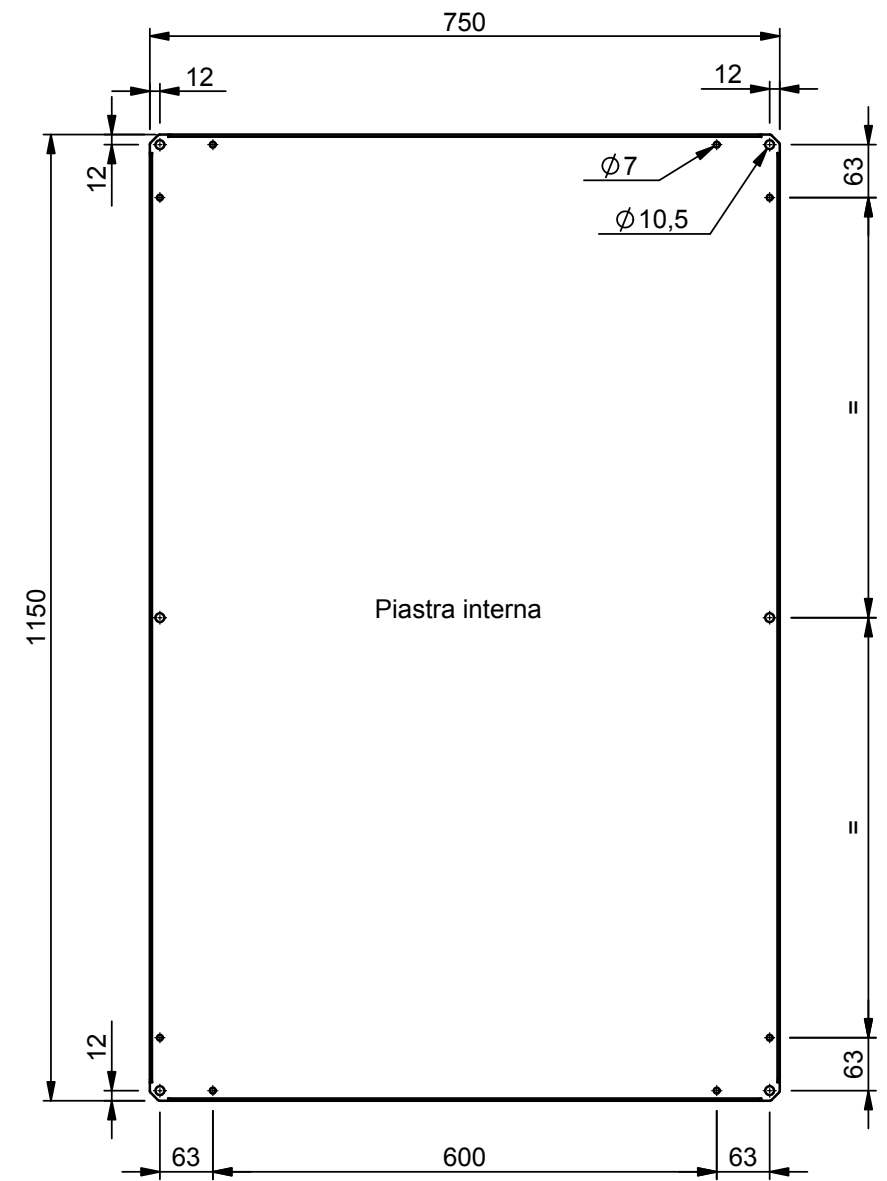
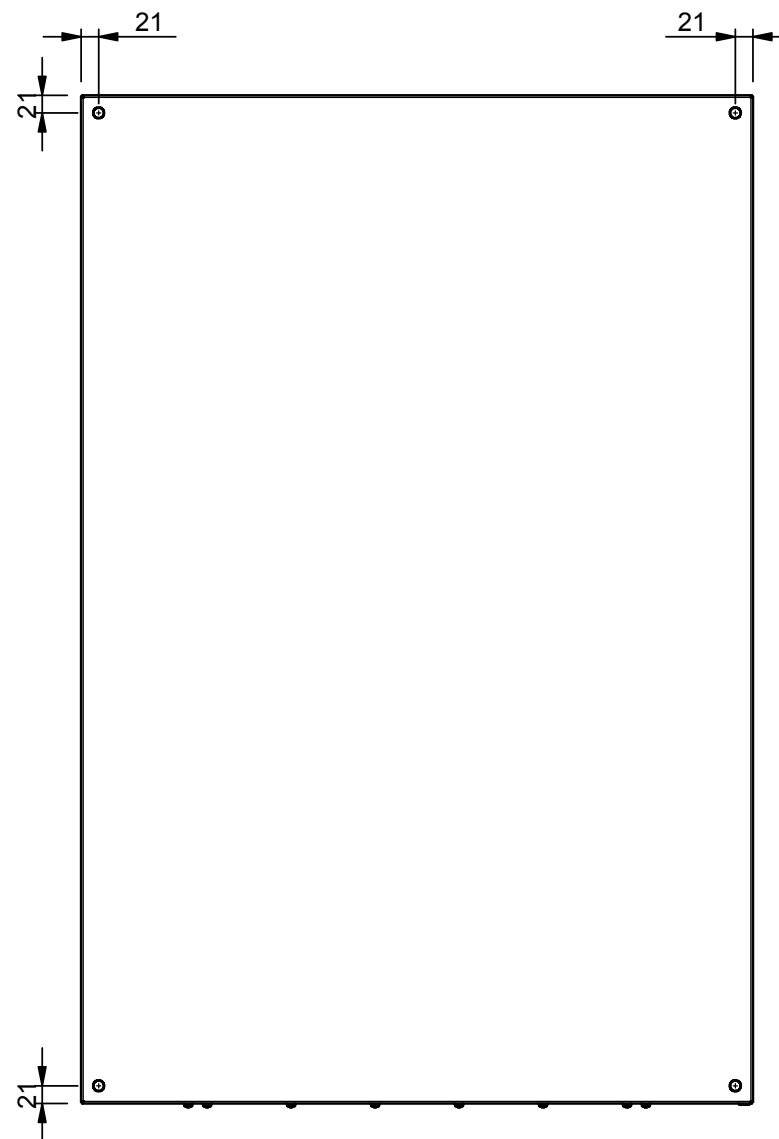

ST8_1230