

SEZIONE A-A

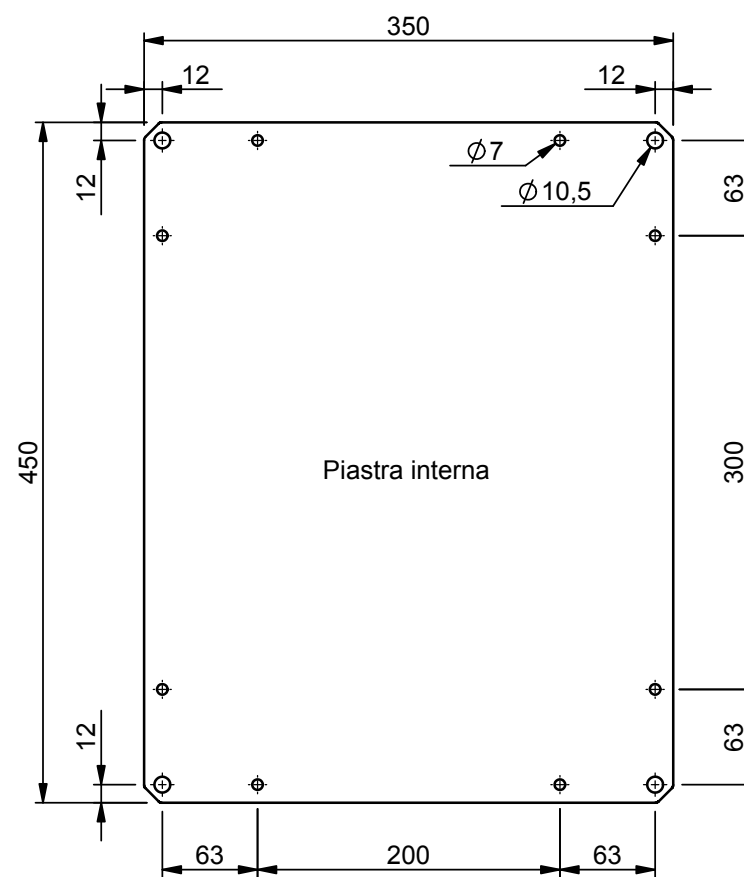

CASSE ST
400X500X250

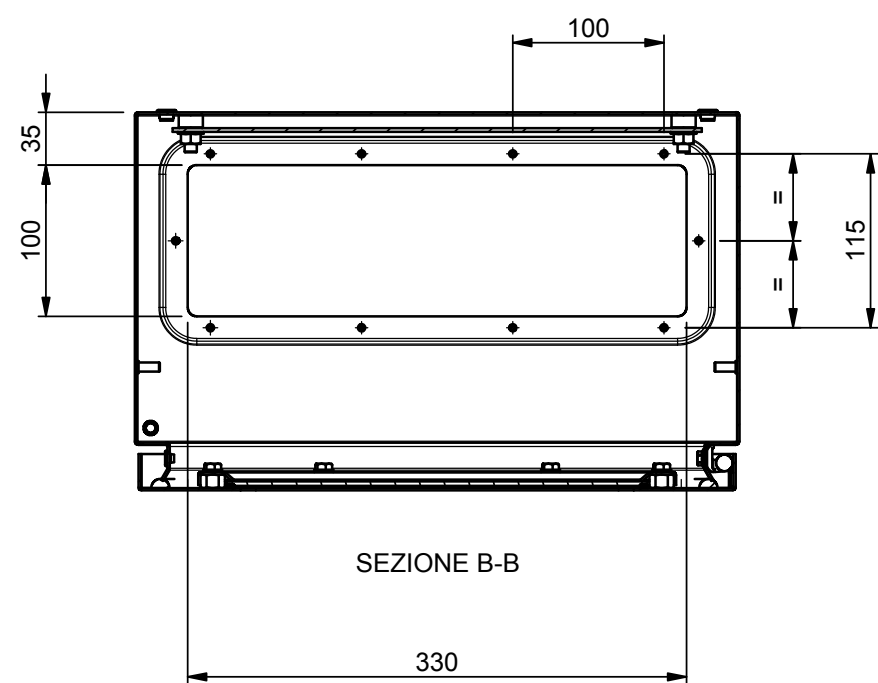
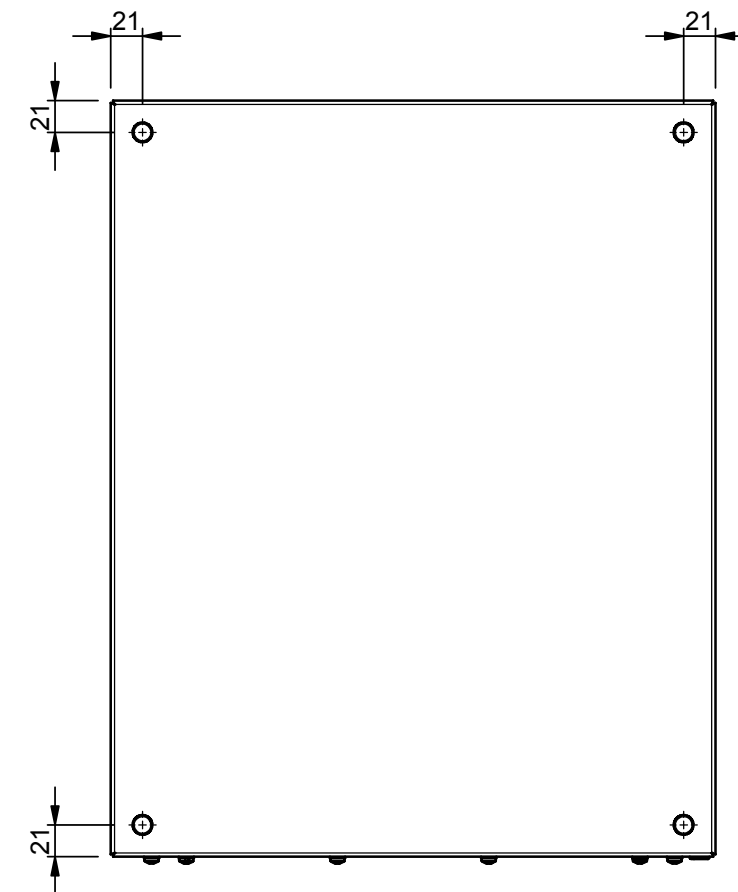

STP4_525 Porta finestra